

Tippette

Full Sized Rocker Switches

The Tippette Series is a traditionally styled rocker switch, available in sealed or unsealed versions. These switches are appropriate for use in general purpose applications which may or may not require a modicum of environmental protection. The Tippette Series is available in both illuminated and non-illuminated versions and features a wide variety of circuits, actuator styles and bracket options. This versatile offering includes international agency certifications and ratings to 26 amps for select circuits.



Carling Technologies®

Innovative Designs. Powerful Solutions.

Innovative Designs. Powerful Solutions.

Carling Technologies, Inc.
60 Johnson Avenue • Plainville, CT 06062-1177
Phone: (860) 793-9281 • Fax: (860) 793-9231
Email: sales@carlingtech.com • www.carlingtech.com

Electrical

Contact Rating	15 amps, 125 VAC 10 amps, 250 VAC 3/4 HP 125-250 VAC 15 amps, 12-30 VDC
Life	25,000 cycles circuit dependent 50,000 cycles circuit dependent consult factory for applicable circuits.
Contacts Terminals	Fine silver, silver cad-oxide Brass or copper/silver plate 1/4" (6.3mm) Quick Connect terminations standard. Solder lug - Brass Tin Plated Wire Lead 16 gauge standard 105°C 600VAC Screw Terminals - Brass

Mechanical

Endurance	100,000 cycles minimum
-----------	------------------------

Physical

Lighted	Incandescent - rated 10,000 hours Neon - rated 25,000 hours
Seals	Bracket - Actuator WBL/MBL optional external gasket panel seal
Base	Phenolic (150°C)
Rocker/Bracket	Nylon 66 (105°C)

Agency Certifications



Select circuits and constructions with IEC approvals are available. Consult factory

Mounting

MOUNTING HOLE
(Nylon Snap-in Brackets)
Panel Thickness:
.040 min. - .250 max.



*Angled corners are suggested for optimum fit.
Standard rectangular cutout is acceptable.

*Manufacturer reserves the right to change product specification without prior notice.

TIGA51 - 6M - BL - MBL

1 Base Part Number 2 Actuator Style 3 Actuator Color 4 Bracket

1 BASE PART NUMBER: SERIES/POLES/CIRCUITRY^{8,11,13}/RATING⁷/TERMINATION¹⁰

10A 250VAC, 15A 125VAC, 3/4 HP 125-250VAC, 15A 6-28VDC⁷
Single Pole in Double Pole base²

solder lug	.250 tab	screw term.	wire lead	
TIGA50	TIGA51	TIGA54	TIGA55	On-None-Off
TIGA5A	TIGA5B	TIGA5E	TIGA5F	(On)-None-Off
TIGA5L	TIGA5M	TIGA5S	TIGA5T	On-None-(Off)
TIGB50	TIGB51	TIGB54	TIGB55	On-None-On
TIGB5A	TIGB5B	TIGB5E	TIGB5F	On-None-(On)
TIGC50	TIGC51	TIGC54	TIGC55	On-Off-On
TIGC5A	TIGC5B	TIGC5E	TIGC5F	On-Off-(On)
TIGC5L	TIGC5M	TIGC5S	TIGC5T	(On)-Off-(On)

Double Pole

solder lug	.250 tab	screw term.	wire lead	
TIGK50	TIGK51	TIGK54	TIGK55	
TIGK5A	TIGK5B	TIGK5E	TIGK5F	
TIGK5L	TIGK5M	TIGK5S	TIGK5T	
TIGL50	TIGL51	TIGL54	TIGL55	
TIGL5A	TIGL5B	TIGL5E	TIGL5F	
TIGM50	TIGM51	TIGM54	TIGM55	
TIGM5A	TIGM5B	TIGM5E	TIGM5F	
TIGM5L	TIGM5M	TIGM5S	TIGM5T	

Three Pole

solder lug	.250 tab	screw term.	wire lead	
TIHK50	TIHK51	TIHK54	TIHK55	On-None-Off
TIHK5A	TIHK5B	TIHK5E	TIHK5F	(On)-None-Off
TIHK5L	TIHK5M	TIHK5S	TIHK5T	On-None-(Off)
TIHL50	TIHL51	TIHL54	TIHL55	On-None-On
TIHL5A	TIHL5B	TIHL5E	TIHL5F	On-None-(On)
TIHM50	TIHM51	TIHM54	TIHM55	On-Off-On
TIHM5A	TIHM5B	TIHM5E	TIHM5F	On-Off-(On)
TIHM5L	TIHM5M	TIHM5S	TIHM5T	(On)-Off-(On)

VDE APPROVED

10A 250VAC, 15A 125VAC, 12(6)A 250VAC T85

Single Pole in Double Pole base²

solder lug	.250 tab	wire lead	
TIGA90	TIGA91	TIGA95	On-None-Off
TIGB90	TIGB91	TIGB95	On-None-On
TIGC90	TIGC91	TIGC95	On-Off-On

Double Pole

solder lug	.250 tab	wire lead	
TIGK90	TIGK91	TIGK95	
TIGL90	TIGL91	TIGL95	
TIGM90	TIGM91	TIGM95	

Additional ratings up to 20A 125-277VAC, 1 1/2HP 125 VAC, 2HP 250VAC are available. Consult factory for specifics.

2 ACTUATOR STYLE

1S	Angular/Smooth Face Gloss ¹²	6M	Curved/Smooth Face Matte ³
1C	Angular/Cross Serrations Gloss ¹²	6S	Curved/Smooth Face Gloss ³
1F	Flatted/Smooth Face Gloss ¹²	7S	Rounded Paddle/Smooth Face Gloss ¹
1L	Angular/Longline Serrations Gloss ^{1,12}	7N	Witch's Hat/Narrow ¹⁵
2L	Long Smooth/Narrow ¹⁵	7P	Witch's Hat/Wide ¹⁵

3 ACTUATOR COLOR⁹

BL black WH white RD red

4 BRACKET STYLE⁹

A	Screw Mount ⁵
B	Screw Mount ^{5,12}
C	Screw Mount ⁵
H	Screw Mount ⁵
NBL	Nylon Black
WBL	Watershedding Black ⁴
MBL	Marine Style Black ^{4,6}
FN	Metal Snap-In ⁵
FN BLK	Black Metal Snap-In ⁵
FN SS	Stainless Steel Snap-In ⁵
FW	Wide Stainless Steel Snap-In ⁵

Notes:

- NBL, FN, & FW brackets only.
- For single pole switch in a single pole base, specify TIL with single pole circuitry/rating/termination.
- NBL, WBL, & MBL brackets only. With 6M actuator, brackets also will be matte finish.
- 6M & 6S actuators only.
- Not available with 6M & 6S actuators.
- Consists of WBL bracket, neoprene seal, and dummy rivets at open holes. Consult factory for agency approval status.
- All ratings are appropriate for usage in low voltage applications.
- For additional special circuits, see page 21.....?!?!?
- Custom colors are available, consult factory.
- .187 tab and PC terminations are also available. Consult factory for catalog number callout.
- () momentary
- Not available with WBL or MBL style brackets.
- Additional circuits available. See page 21.
- Available with bracket A, C or H only.
- Not available with MBL, WBL or H brackets. Can be supplied as a double rocker to control separate poles of a TIG, TIH or TII switch. Consult factory for details.

LTILA51 - 6M - BL - RC - MBL - 12V

1 Base Part Number 2 Actuator Style 3 Actuator Color 4 Lens Color 5 Bracket 6 Lamp Voltage

1 BASE PART NUMBER: SERIES/POLES/ILLUMINATION/CIRCUITRY¹²/RATING¹⁰/TERMINATION¹⁴

10A 250VAC, 15A 125VAC, 3/4 HP 125-250VAC, 15A 15-28VDC
Illuminated Single Pole in Double Pole base

solder lug	.250 tab	screw term.	wire lead	
LTILA50	LTILA51	LTILA54	LTILA55	On-None-Off
LTILA5A	LTILA5B	LTILA5E	LTILA5F	(On)-None-Off
LTILA5L	LTILA5M	LTILA5S	LTILA5T	On-None-(Off)
LTILB50	LTILB51	LTILB54	LTILB55	On-None-On
LTILB5A	LTILB5B	LTILB5E	LTILB5F	On-None-(On)
LTILC50	LTILC51	LTILC54	LTILC55	On-Off-On
LTILC5A	LTILC5B	LTILC5E	LTILC5F	On-Off-(On)
LTILC5L	LTILC5M	LTILC5S	LTILC5T	(On)-Off-(On)

Illuminated Double Pole

solder lug	.250 tab	screw term.	wire lead	
LTIGK50	LTIGK51	LTIGK54	LTIGK55	
LTIGK5A	LTIGK5B	LTIGK5E	LTIGK5F	
LTIGK5L	LTIGK5M	LTIGK5S	LTIGK5T	
LTIGL50	LTIGL51	LTIGL54	LTIGL55	
LTIGL5A	LTIGL5B	LTIGL5E	LTIGL5F	
LTIGM50	LTIGM51	LTIGM54	LTIGM55	
LTIGM5A	LTIGM5B	LTIGM5E	LTIGM5F	
LTIGM5L	LTIGM5M	LTIGM5S	LTIGM5T	

Additional ratings up to 12A 250VAC, 17A 125 VAC, 3/4 HP 125 VAC, 1HP 250VAC are available. Consult factory for specifics.

Three pole switch is also available: Substitute H for fourth digit of part number. ex. LTIIHK51

2 ACTUATOR STYLE⁴

1S	Angular/Smooth Face Gloss ¹
1C	Angular/Cross Serrations Gloss ¹
1L	Angular/Longline Serrations Gloss ¹
6M	Curved/Smooth Face Matte ³
6S	Curved/Smooth Face Gloss ³
7S	Rounded Paddle/Smooth Face Gloss ²

3 ACTUATOR COLOR¹¹

BL black WH white RD red

4 LENS COLOR¹³

AM	amber	RC	red	GN	green ⁷
LU	blue ⁷	CL	clear	WH	white

5 BRACKET STYLE¹¹

NBL	Nylon Black
WBL	Watershedding Black ⁵
MBL	Marine Style Black ^{3,8}
FN	Metal Snap-In ^{4,6}
FN BLK	Black Metal Snap-In ^{4,6}
FN SS	Stainless Steel Snap-In ^{4,6}

6 LAMP VOLTAGE

neon ⁹	125N	125 volt	250N	250 volt
incandescent	6V	6 volt	12V	12 volt
	24V	24 volt	28V	28 volt
			18V	18 volt

Notes:

- NBL, FN, & FW brackets only. Double pole circuits provided with 3 pole base.
- LTIL-Series with NBL, FN, & FW brackets only.
- NBL, WBL, & MBL brackets only. With 6M actuator, bracket will also be matte finish.
- 1S, 1C, 1L & 7S with NBL bracket only available with LTIL-Series.
- 6M, 6S actuators only.
- Not available with 6M and 6S actuators.
- Not recommended with neon lamps.
- Consists of WBL bracket, neoprene seal, dummy rivets at open holes. Consult factory for agency approval status.
- Not recommended with blue or green lenses.
- All ratings are appropriate for usage in low voltage applications.
- Custom colors and additional bracket styles are available, consult factory.
- () - momentary
- All double throw circuits supplied with two lenses. To specify two different lens colors, specify second color, after first color. (ex. LTIGM51-6S-BL-RC/GN-WBL-12V)
- .187 tab and PC terminations are also available. Consult factory for catalog number callout.

1C
CROSS-LINE W/ONE LENS



WITH .250 TAB
TERMINALS
AND NBL BRACKET

1L
LONG-LINE W/ONE LENS



WITH SOLDER LUG
TERMINAL
AND NBL BRACKET

1S
SMOOTH W/ONE LENS



WITH .250 TAB
TERMINALS
AND NBL BRACKET

1F
FLATTED STYLE NO LENS

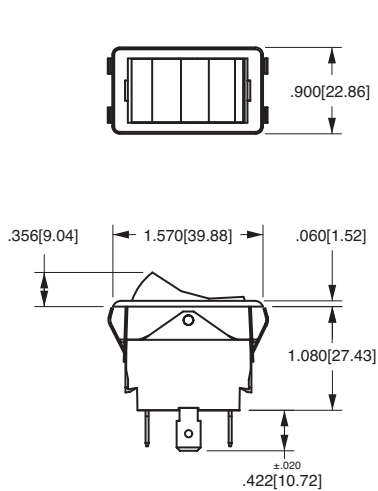

WITH .250 TAB
TERMINALS
AND FN BRACKET

6M, 6S
CURVED W/ONE LENS

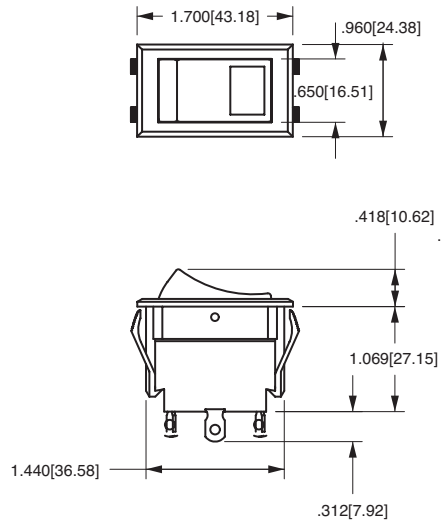

WITH SOLDER LUG
TERMINALS
AND NBL BRACKET

7S
TOGGLE-STYLE W/ONE LENS

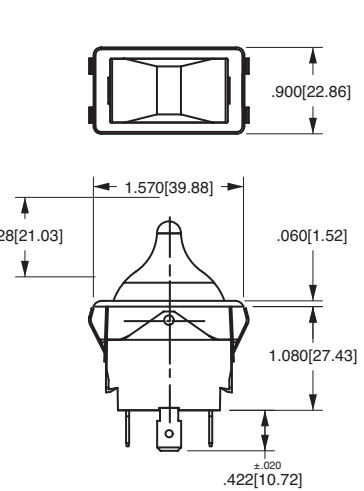

WITH .250 TAB
TERMINALS
AND FN BRACKET

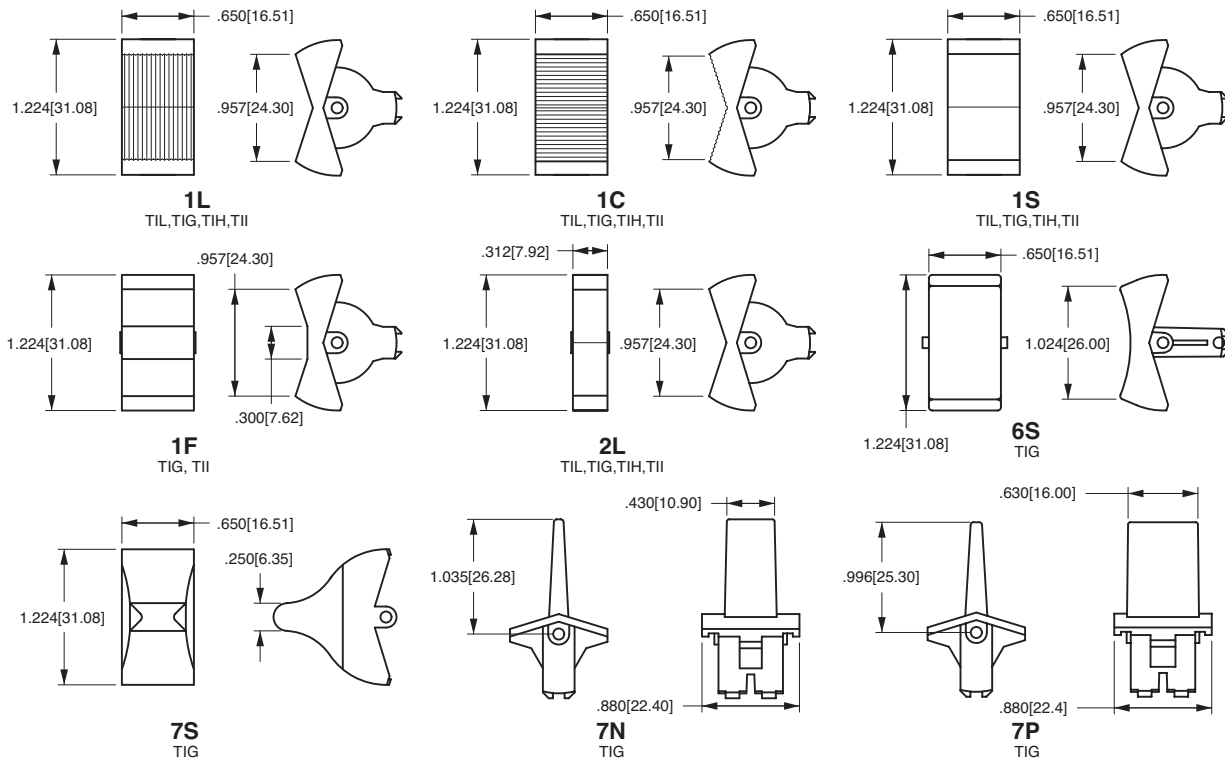

SPECIAL CIRCUITS FOR TIPPETTE ROCKER SWITCHES

Circuit	Position 1	Position 2	Position 3
Progressive Two Circuit			
GG	BOTH CIRCUITS ON	ONE CIRCUIT ON	OFF
GG	BOTH CIRCUITS (ON)	ONE CIRCUIT ON	OFF
Single Pole Triple Throw			
GE	ON	ON	ON
Two Circuit			
GH	CIRCUIT 1 ON	BOTH CIRCUITS ON	CIRCUIT 2 ON
GP	CIRCUIT 2 ON	CIRCUIT 1 ON	OFF
Reversing Double Pole			
GO	ON	OFF	ON
GX	ON	NONE	ON

() Indicates momentary function.

Dimensional Specifications: in. [mm]

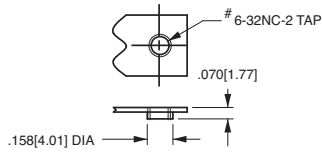

TAPPED HOLE
Standard with
A & B Brackets

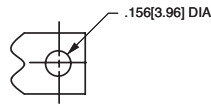

CLEARANCE HOLE
Standard with
C Bracket

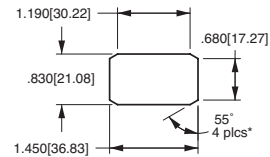

MOUNTING HOLE
(Nylon Snap-in Brackets)
Panel Thickness:
.030 min. - .250 max.

* Angled corners are suggested for optimum fit. Standard rectangular cutout is acceptable.

TIL	TIG	TII	TIH
<p>A TIL</p>	<p>A TIG</p>	<p>A TII</p>	<p>A TIH</p>
<p>B TIL</p>	<p>B TII, TIG</p>		
<p>CX TIL</p>	<p>C TIG</p>	<p>C TIH, TII</p>	

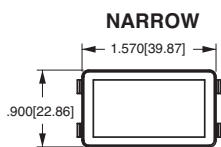
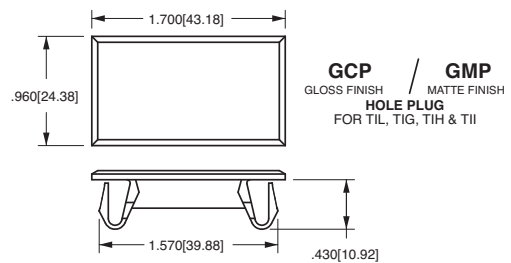
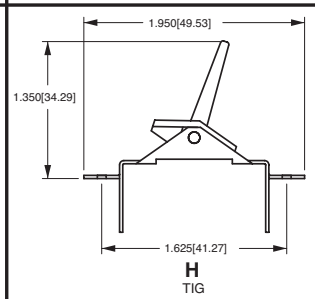

FN
TIL, TIG, TIH, TII
METAL, SNAP-IN

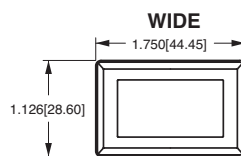

FW
TIL, TIG, TIH, TII
METAL, SNAP-IN

MARINE / STD / WATERSHEDDING

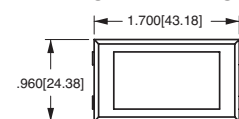

MBL, NBL, WBL
TIG
BLACK NYLON, SNAP-IN